

CTC EZIPROG 3 (EP3) 3 Channel Programmer

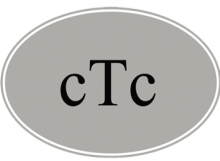

Chronotherm Controls Ltd
sales@chronotherm.ie

Version 4.2



User &
Installation
Instructions

INDEX

User instructions

Introduction	1
Programmer Summary	2
Configuration	3
Built in Programme	4
Factory Programme Settings	4
Selecting Operating mode	5
Setting Time and Date	6
Setting the Back Light	7
Changing Programme Times	8
Programming Notes	10
Reset	10
Using Advance	11
Using the HR+ Boost	12
Linked Central Heating and Hot Water Times	14
Power Interruption	14

INDEX

Installation Instructions

Technical Data	15
Pre- Installation Product Set Up	16
Installation Safety Notes	16
Fitting Black Plate- Direct Wall Mounting	17
Fitting Black Plate- Wiring Box Mounting	17
New Installations	18
Cylinder and Room Thermostat Key	18
Existing Installations	19
Electrical Connections	20
Fitting the Programmer	20
Commissioning	21

User Instructions

INTRODUCTION – What is a programmer?... an explanation for householders

Programmers allow you to set 'On' and 'Off' time periods. Some models switch the central heating and domestic hot water on and off at the same time, while others allow the domestic hot water and heating to come on and go off at different times. Set the 'On' and 'Off' time periods to suit your own lifestyle.

On some programmers you must also set whether you want the heating and hot water to run continuously, run under the chosen 'On' and 'Off' heating periods, or be permanently off. The time on the programmer must be correct. Some types have to be adjusted in spring and autumn upon the changes between Winter and Summer time.

You may be able to temporarily adjust the heating programme, for example, 'Override', 'Advance' or 'Boost'. These are explained in the manufacturer's instructions. The heating will not work if the room thermostat has switched the heating off. And, if you have a hot water cylinder, the water heating will not work if the cylinder thermostat detects that the hot water has reached the correct temperature.

Commissioning

Switch on mains supply. Referring to the user guide:

1. Use the buttons to ensure correct product functionality.
2. Set timing and programme details in accordance with customer requirements.
3. Normally unit will be left with channel in 'Auto' mode.
4. Set backlight either permanently ON or OFF in accordance with customer requirements (refer to SETTING THE BACK LIGHT in User Installations).
5. Leave these installation instructions with customer for reference.

In the interests of continuous product improvement we reserve the right to alter designs, specifications and materials without prior notice and cannot accept liability for errors.

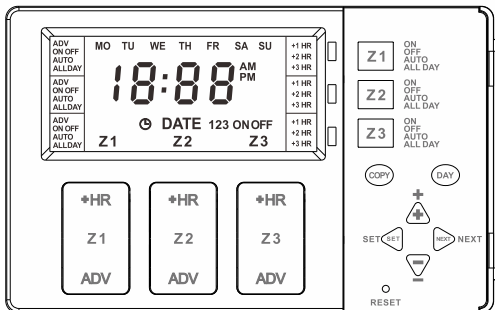

Electrical Connections

Internal Wiring Diagram

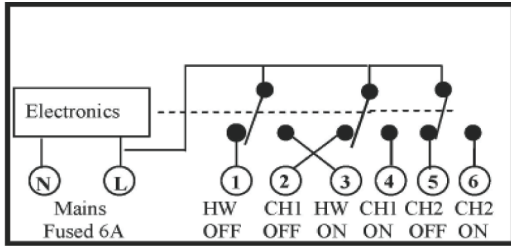

Fitting the Programmer

Loosen the two 'captive' retaining screws on the bottom of the back plate. Now fit the programmer to the back plate, ensuring the lugs of the back plate engage with the slots on the programmer. Swing the bottom of the programmer into position ensuring the connection pins on the back of the unit locate into the terminal slots in the back plate. Tighten the two 'captive' screws to fix the unit securely.

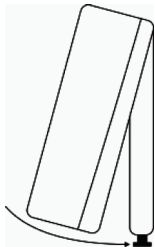

PROGRAMMER SUMMARY



This programmer can automatically switch your central heating or hot water ON and OFF up to 3 times a day, at whatever times you choose. Timekeeping is maintained through power interruptions by a non replaceable battery designed to last for the lifetime of the programmer and the clock is automatically put forward 1 hour at 1:00am on the last Sunday of March and back 1 hour at 2:00am on the last Sunday of October. The clock is factory pre-set to UK time and date, but you can alter it if you wish. During installation, the installer selects 24 hour, or 5 day/2day, or 7 day programming and 2 or 3 on/off periods per day, via a 4 position DIP switch on the back of the unit (see installation instructions).

- The 24 hour programmer option runs the same programme every day.
- The 5 day/2 day programmer option allows different ON/OFF times at weekends.
- The 7 day programmer option allows different ON/OFF times for each day of the week.
- Pumped System (PU) allows independent control of Central Heating and Hot Water.
- Gravity System (Gr) does not allow Central Heating without Hot Water but can provide Hot Water without Central Heating.

IMPORTANT: These settings should only be changed by a qualified person. Contact your installer.

IMPORTANT: This programmer is not suitable for the switching of devices greater than 6Amp rated. (e.g. Not suitable for use as an immersion timer)

The large, easy to read display makes programming easy and the unit is designed to eliminate the possibility of accidental changes to your programme. Buttons normally visible, only affect your set programme temporarily. All buttons which can permanently change your programme are located behind the flip over facia.

CONFIGURATION

When setting time, date or changing programme times the first screen displayed indicates the configuration as set up by the installer. (See SETTING THE TIME section)

Configuration	Display	Programme Notes
2 ON/ OFF Pumped system	2PU	Times for Central Heating and Hot Water can be independently set.
3 ON/ OFF Pumped System	3PU	Times for Central Heating and Hot Water can be independently set.
2 ON/ OFF Gravity system	2Gr	Times for Central Heating and Hot Water can be independently set. But Heating CH1 will always bring Hot Water and CH2 ON.
3 ON/ OFF Gravity system	3Gr	Times for Central Heating and Hot Water can be independently set. But Heating CH1 will always bring Hot Water and CH2 ON.

The 24 hour, 5 day/2day, or 7 day programming options as set up by the installer can also be verified at this stage by how the Monday to Sunday indicators are displayed.

Programming Option	Monday to Sunday Indicators Flash
7 DAY	Mon to Sun individually shown
5/2 DAY	Mon to Fri together then Sat & Sun together shown
24 HOUR	Mon to Sun together shown

Now press the set button to move to Setting the Time and Day.

Existing Installations

1. Remove old programmer from its back plate mounting loosening any securing screws as dictated by its design.
2. Check compatibility of existing back plate & wiring arrangement with that of the new programmer. See online Programmer Replacement Guide for direction.
3. Make all necessary changes to back plate & wiring arrangement to suit new programmer.

N.B!! Isolate all power supply before fitting and wiring back plate, and before mounting programmer on back plate.
A 3-6 Amp fused spur is recommended and in most installations compulsory.
(This programmer has a 6 Amp rating)

New Installations

Example circuit diagram for a typical installation is shown below. This diagram is schematic and should be used as a guide only.

Please ensure that all installations comply with the current IEE regulations.

For reasons of space and clarity the diagram has been simplified. For instance some Earth connections have been omitted. Other control components shown in the diagram i.e. Valves, Room Stats etc are general representations only. However, the wiring detail can be applied to the corresponding model of most manufacturers e.g. Horstmann, Honeywell, Danfoss Randall, Drayton etc.

Cylinder and Room Thermostat Key

C=Common

Call = Call for heat or break on rise

SAT = Satisfied on rise

N= Neutral

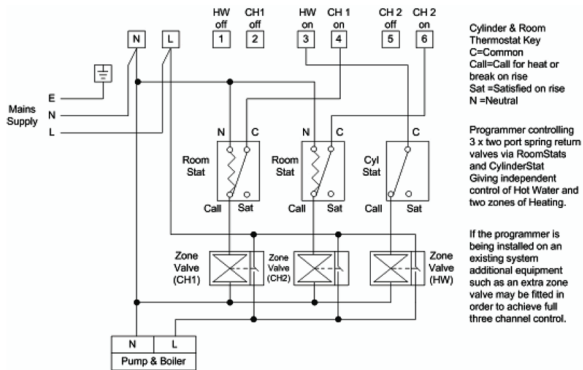

BUILT IN PROGRAMME

For convenience, the programmer has a built in programme which will be satisfactory for many people, but which can be changed very easily (see section CHANGING PROGRAMME TIMES). Once the unit is powered up this built in programme will run.

If the user changes from the built in programme and wishes to return to it, then pressing the reset button with a non metallic pointed tool will return the unit to the built in / default programme.

NOTE:

Every time the reset is pressed, the time and date must be set again. See the sections SETTING THE TIME & SETTING THE DATE

Factory Programme Settings (Heating 1, 2, and Hot Water)

Configuration 2PU & 2Gr	Configuration 3PU & 3Gr	Mon-Fri	Sat-Sun
1st ON	1st ON	06:00am	07:00am
1st OFF	1st OFF	08:30am	09:00am
—	2nd ON	12.00noon	12.00noon
—	2nd OFF	12.00noon	12.00noon
2nd ON	3rd ON	04:30pm	04:30pm
2nd OFF	3rd OFF	10.30pm	11.00pm

If the unit is installed as a 24 hour programmer the built in programme will be the same for each day (i.e. Sat-Sun be same as Mon-Fri above).

SELECTING OPERATING MODE

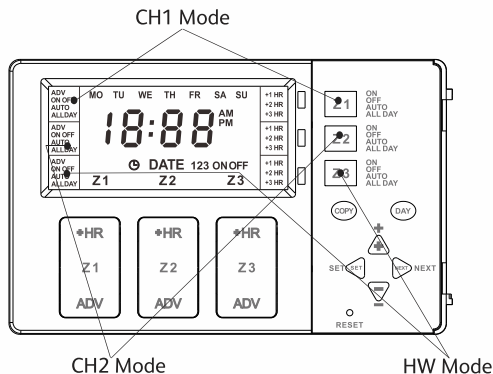

ON	Central Heating and Hot Water is ON continuously
AUTO	Central Heating and Hot Water will be switched ON and OFF in accordance with set programmes
ALL DAY	Central Heating and Hot Water will switch ON at the first ON and switch OFF at last OFF
OFF	Central Heating and Hot Water permanently OFF

Fitting Back Plate – Direct Wall Mounting

1. Position the wall-plate (terminals along top edge) with 60mm (min) clearance to its right, 25mm (min) above, 90mm (min) below. Ensure that the supporting surface will fully cover the back of the programmer.
2. The ideal location would be 1.4M above floor level, easily accessible, reasonably lit and free from condensation or temperature extremes. **N.B!! Fitting programmer too high may lead to difficulty in reading LCD screen.**
3. Offer the back plate to the wall in the position where the programmer is to be mounted remembering that the back plate fits to the left hand end of the programmer. Mark the fixing positions through the slots in the back plate, drill and plug wall, then secure back plate in position.

4. All necessary electrical connections should now be made. Ensure that the wiring to the wall-plate terminals leads directly away from the terminals and is completely enclosed within the wall-plate aperture. Wire ends must be stripped and screwed to the terminals so that minimal bare wire is showing.

Fitting Back Plate – Wiring Box Mounting

1. Fix the wall-plate to a flush mounting single conduit box type UA1 (BS4662) using M3.5 x 14 bolts. Take care to ensure the opening is adequate and will allow mounting of the unit onto the base plate. Also, the use of glue, mastic, or other sealants should not be required to secure the unit to the wall if the correct fitting instructions are followed.
2. All necessary electrical connections should now be made. Ensure that the wiring to the wall-plate terminals leads directly away from the terminals and is completely enclosed within the wall-plate aperture. Wire ends must be stripped and screwed to the terminals so that minimal bare wire is showing.

Pre-Installation Product Set Up

Before installing, set the bank of 4 DIP Switches on the back to configure the unit according to the chart below:

Pumped		Gravity
24 Hr		7 Day
		5/2 Day
2 On/Off		3 On/Off

DIP Switches: Shown in Factory Default Positions.

PUMPED – allows independent control of CH and HW.

GRAVITY – does not allow CH1 without HW and CH2, but can provide HW without CH1 and CH2 and CH2 without CH1 and HW

24 Hr – runs same programme every day.

5/2 Day – allows different on/off times at weekend.

7 day – allows different on/off times every day.

Installation Safety Notes

This unit must be installed by a suitably qualified person in accordance with the latest IEE Wiring Regulations.

Isolate mains supply before commencing installation. Please read all installation instructions before proceeding.

Ensure that the fixed wiring connections to the mains supply is via a fuse rated at not more than 6 amps and a class 'A' switch having a contact separation of a minimum of 3mm in all poles. The recommended cable sizes are 1.0mm sq or 1.5mm sq.

If the unit is fitted to a metal surface, IT IS ESSENTIAL that the metal be earthed. DO NOT use a surface mounting box.

No earth connection is required as the product is double insulated but ensure continuity of earth throughout the system.

NEVER fit or remove the unit to a live wall-plate.

SETTING THE TIME

- Press the SET button (1) once. The configuration setting will appear on the screen. (E.G. 2PU)
- Press the SET button (1) again. The clock icon (2) on the screen will flash.
- Press the +/- buttons (3) to adjust the time. Time will change quicker if pressed continually.
- Press SET (1) once to move on to setting the DATE or press multiple times to return to RUN mode.

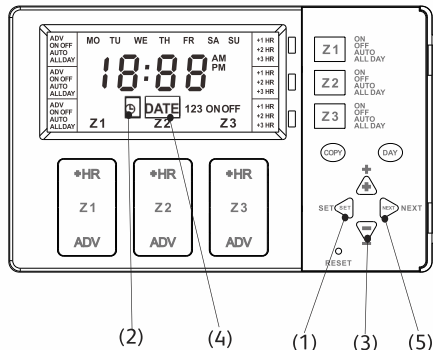

SETTING THE DATE

- Press the SET button (1) until the Y:XX icon (Year) appears and the D (DATE) icon (4) flashes.
- Press the +/- button (3) to set the year.
- Press NEXT button (5). M:XX appears (Month).
- Press +/- button (3) to set month.
- Press NEXT button (5). D:XX appears (Day).
- Press +/- button (3) to set day.

You can review or edit the date you have set just by pressing NEXT button (5) again and repeating the sequence above. To confirm the date and move on to PROGRAM mode press SET button (1) once or press SET button (1) multiple times to return to RUN mode.

Setting the Backlight

The backlight can either be set permanently ON or OFF. The programmer backlight is pre-set to be permanently OFF. When backlight is permanently OFF, the backlight will turn ON for 15 seconds when + or – button is pressed, then turn OFF automatically. To change setting to permanently ON, press SET repeatedly until L IR is displayed. Press + or – to turn backlight ON or OFF. Press SET to confirm.

Do not use Advance or Boost Button to activate the backlight as it may engage the Boost or Advance facility and bring on the boiler.. Only use +/- Button under facia cover.

Technical Data

Power Supply	230V AC, 50Hz
Operating Temperature	0°C to 35°C
Switch Rating	230V AC, 6(2)A SPDT
Battery Type	Lithium Cell CR2032
Enclosure Protection	IP30
Plastics	Thermoplastic, flame retardant
Insulation Class	Double
Wiring	For fixed wiring only
Back Plate	Industry standard
Dimensions	140mm x 87mm x 37mm
Clock	12 hour am/pm, 1 minute resolution
BST/GMT time change	Automatic
Clock Accuracy	+/- 1 sec/day
Programme Cycle	24hr, 5/2day or 7day selectable
Programme On/off per day	2 on/off, 3on/off selectable
Programme Selection	Auto, On all day, On constant, Off
Programme Override	+1,2 or 3Hr, Advance
Heating System	Pumped, Gravity selectable
Complies with	EN60730-1, EN60730-2.7, EMC Directive 2004/108/EC, LVD Directive 2006/95/EC

CHANGING PROGRAMME TIMES

The built in programmes can easily be changed to better suit your needs.

To change the Heating times

- Press SET button (1) until first radiator icon (2) flashes in the display and 1 ON (3) appears.
- By pressing the +/- buttons (4) you can alter the ON time to the time you want.

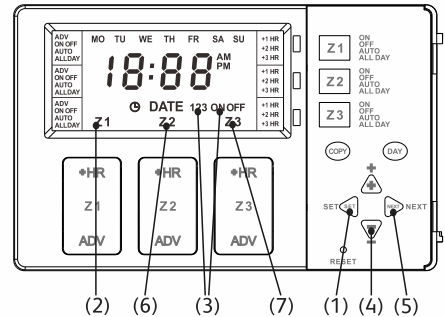

Installation Instructions

- Press NEXT button (5), display will now show 1 OFF (3).
- By pressing the +/- buttons (4) you can alter the OFF time to the time you want.
- Press NEXT button (5) to access remaining ON/OFF periods and alter in same manner as above.
- Press Set Button (1) to access Heating Zone 2. The second radiator icon (6) will flash. Repeat procedures for CH1 if you wish to change CH2 programme times.
- To return to RUN mode, press the SET button until the display indicates RUN on the display.

NOTE: Programming is in 10 minute segments.

To change the Hot Water times

Press SET button (1) until tap icon (7) flashes in the display and 1 ON (3) appears. This indicates the time shown on the display is the first ON time and proceed in same manner as 'To change the Central Heating Times' above.

7 day programmer option

If the unit is installed as a 7 day programmer, the initial programme displayed will be for Monday. You can go to any day of the week by pressing the DAY button repeatedly.

The ON/OFF times can be changed for each day as described above in the section "CHANGING PROGRAMME TIMES".

If you press the COPY button, the current programme will be copied onto the next day.

NOTE: it is not possible to copy Sunday to Monday.

5 day /2 day programmer option

If the unit is installed as a 5 day/2 day programmer, the initial programme displayed will be for Monday to Friday.

Pressing the DAY button will take you to the programme for Saturday and Sunday.

The ON/OFF times can be changed for each day group as described above in the section "CHANGING PROGRAMME TIMES".

If you press COPY button, the current programme will be copied onto the next day group. Monday to Friday group to Saturday/Sunday only.

24 hour programmer option

If the unit is installed as a 24 hour programmer, the built in programme will be the same for each day. The COPY & DAY buttons have no effect if installed as a 24 hour programmer.

LINKED CENTRAL HEATING AND HOT WATER TIMES

To link the programmes hold down the COPY button whilst pressing RESET.

Configuration	Display	Display Programme Notes
2 ON/OFF Pumped System	2PL	Times same & linked for Central heating 2and Hot Water with Central heating 1
3 ON/OFF Pumped System	3PL	Times same & linked for Central heating 2and Hot Water with Central heating 1
2 ON/OFF Gravity System	2GL	Times same & linked for Central heating 2and Hot Water with Central heating 1
3 ON/OFF Gravity System	3GL	Times same & linked for Central heating 2and Hot Water with Central heating 1

The last letter of the configuration (i.e. a U or an r) will now be L if the Central Heating and Hot Water programmes have been linked. In this mode the Hot Water will run from the Central Heating programme, so changes to the programme need only be made once and this will affect both Central Heating and Hot Water.

POWER INTERRUPTION

In the event of a mains supply failure the screen will go blank but the back-up battery ensures that the programmer continues to keep the time and retain your stored programme. When power is restored, if there has been no change to the rear DIP switch, the programmer then goes to RUN mode. If the configuration setting on the rear DIP switch has been altered during the power interruption the screen will initially show the new configuration and the appropriate factory default programme (see BUILT IN PROGRAMME section) will be installed. Press SET button to return to RUN mode.

For +Hr Hot Water

Press the upper half of the Hot Water channel +HR button (3). One press of the button will give one extra hour of heating, two presses of the button will give two extra hours and three presses of the button will give the maximum three extra hours. Pressing it again will switch off the +HR function.

Warning: The +HOUR function is only available when programme is in AUTO, ALL DAY or OFF operating modes.

If the Hot Water operating mode is OFF, then it will switch on for the extra hours selected. If the Hot Water mode is AUTO or ALL DAY, then during an OFF period, it will switch on for the extra hours selected. If during an ON period, then it will temporarily extend that programme by the number of hours selected.

NOTE: If the programmer is in the AUTO or ALL DAY mode and then +HR button is pressed (+1 HR, + 2 HR, or + 3 HR) and the resulting time of the boost overlaps a START / ON time in the programme memory then the boost will disengage.

PROGRAMMING NOTES

The unit will automatically return to RUN mode if a period of 5 minutes passes without any buttons being pressed.

For convenience, to allow for programmes to go past midnight, the programme day is from 03:00am to 02:50am the next day.

If a programme is required to run from 1.00 am to 8.00 am then 2 programmes must be used because it is not possible to programme through 2.50 am. (The programme should be split up into two sections ; 3.00 am > 8.00 am and 1.00 am > 2.50 am).

RESET

Press the reset button with a non-metallic pointed tool to restore the built in programme. As well as restoring the built in programme, it also resets the time to 12:00pm and the date to 01/01/2000. Initially the display shows all segments lit for a few seconds, but then will show the current configuration. See SETTING THE TIME AND DATE section to continue.

NOTE: As a safety feature after reset the unit will be in OFF operating mode. Reselect your required operating mode.

NOTE: Use of excessive force may result in the reset button sticking behind the front cover of the programmer. If this happens the unit will "freeze" - and the button can only be released by a qualified installer

USING ADVANCE

The ADVANCE function allows the user to move to the next ON or OFF programme for a “one off” event, without having to change the programme or use the ON or OFF buttons.

Warning: The ADVANCE function is only available when programme is in AUTO or ALL DAY operating modes.

To advance Central Heating 1 or 2

Press the Central Heating 1 or 2 channel ADV (1 or 2) button. This will turn the Central heating ON if it is in an OFF period and OFF if it is in an ON period. It will stay in this state until either ADV (1 or 2) button is pressed again, or until a programmed ON/OFF period commences. The word ADV will appear in the left hand side of the LCD.

To advance Hot Water

Press the Hot Water channel ADV (3) button. This will turn the Hot Water ON if it is in an OFF period and OFF if it is in an ON period. It will stay in this state until either ADV(3) button is pressed again, or until a programmed ON/ OFF period commences. The word ADV will appear in the left hand side of the LCD.

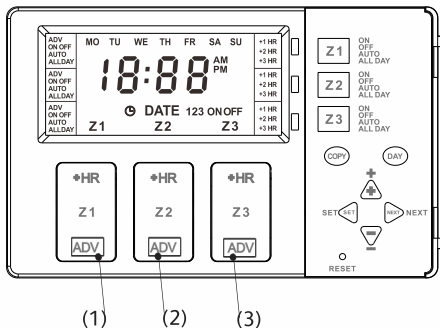

USING THE +HR BOOST

For +Hr Central Heating

Press the upper half of the Central Heating CH1 or CH2 +HR button (1) or (2). One press of the button will give one extra hour of heating, two presses of the button will give two extra hours and three presses of the button will give the maximum three extra hours. Pressing it again will switch off the +HR function.

Warning: The +HOUR function is only available when programme is in AUTO, ALL DAY or OFF operating modes.

If the Central heating operating mode is OFF, then it will switch on for the extra hours selected. If the Central heating mode is AUTO or ALL DAY, then during an OFF period, it will switch on for the extra hours selected. If during an ON period, then it will temporarily extend that programme by the number of hours selected.

The + 1HR, +2HR or +3HR status of each zone will appear on the right of the display.

